



FOUNDATION AUGERS



FOR USE ON THE FOLLOWING CARRIES

Foundation Drill Rigs

 **PENGO**[®]

PENGO AUGER SOIL CHART

Pengo has developed the chart below to help you decide which auger will be best suited for your project. The above triangles and color guide will be included with all products where applicable.



1	dirt; peat, organic silts, very loose sand, very soft, swamp, marsh	soil abrasion: low
2	sand; loose, fine sand; loess and medium clay, flood plain soils, lake clay	soil abrasion: medium
3	silt; coarse sand to stiff clay, dense hydraulic fill, compacted fill, residual soils	soil abrasion: high
4	clay; stiff to very stiff clay, glacial till, hard-pan, marls	soil abrasion: low to medium
5	gravel; basalt, very hard silts and clay, weathered laminated rock	soil abrasion: high
6	fracturable rock; caliche, coarse gravel and cobbles; frozen soil	soil abrasion: high
7	non-fracturable rock; granite, basalt, massive limestone	soil abrasion: high

PENGO FOUNDATION AUGERS

Pengo will commonly refer to the "parts" of the auger to help determine which one is suitable to your needs. Please use the diagram to the right as a reference guide when determining out the auger you would like quoted.

Carrier	Auger(s) Compatible
 Drill Rig	Flat Bottom, S-Pattern, Spiral Rock Augers; Pan Augers; Drill Buckets; Core Barrels

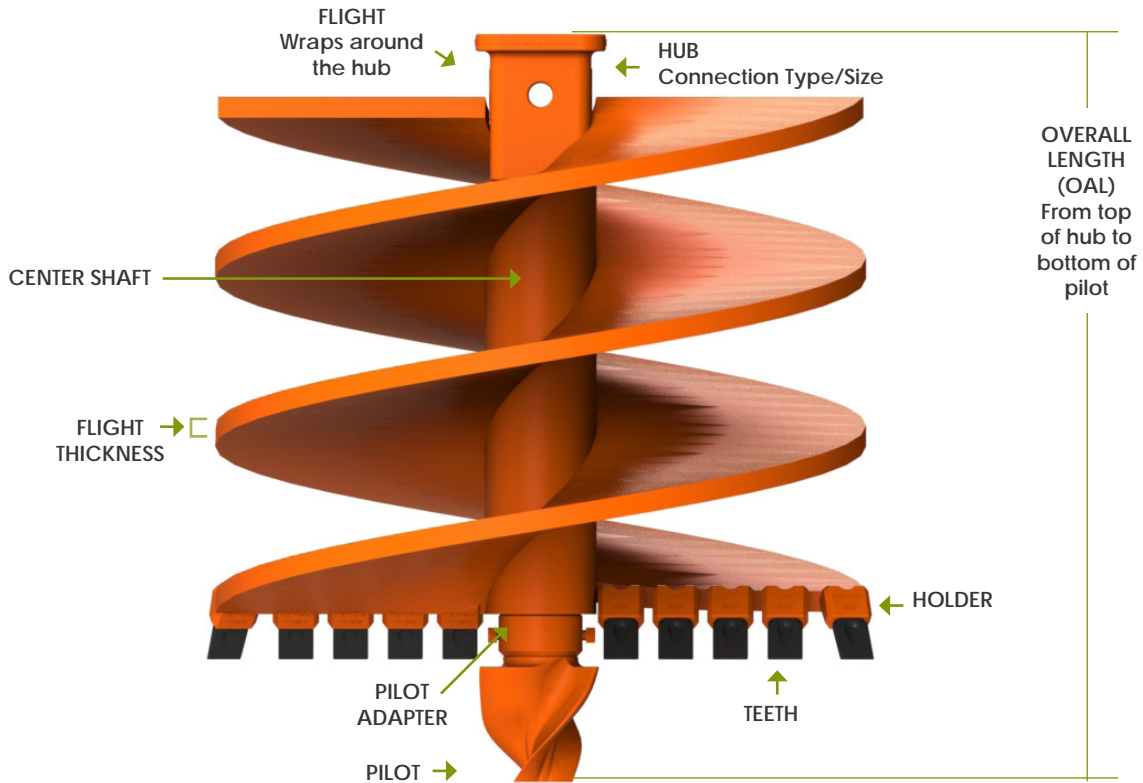



FLAT BOTTOM DIRT AUGER

Double Cut Double Carry shown

Standard Flight Thickness for Lead and Carry Sections:
1", 1 1/2" and 2"

Flight Wraps Around Hub

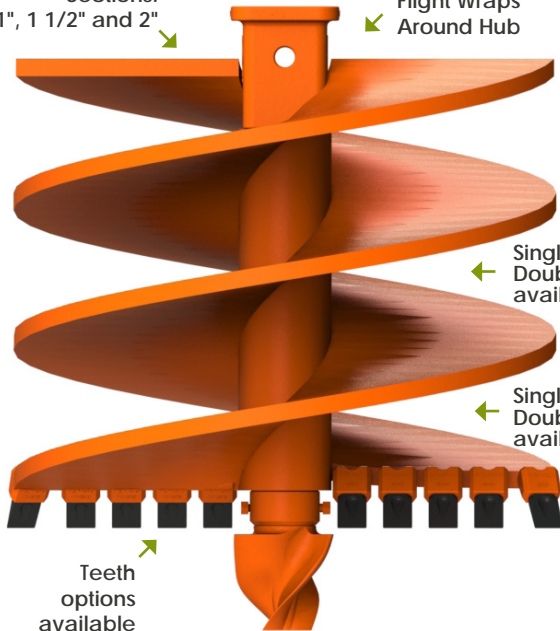

Single Carry and Double Carry available

Single Cut and Double Cut available

Teeth options available

TriFlow® 1000 Pilot

Single Cut Single Carry

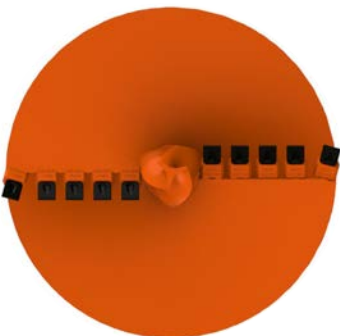

CONNECTIONS

SQUARE	3"	3 1/2"	4"
SQUARE	133MM	150MM	
SQUARE	177MM	200MM	

AUGER DIAMETERS

24" TO 120"

CUT DIAMETER

True Cut diameter is equal to the auger diameter.

DRILLING SOIL CONDITIONS:



Flat bottom dirt augers are perfect to drill holes for concrete footings. With single cut/single carry, double cut/single carry and double cut/double carry flight variations we can accommodate any drilling condition. For added performance and durability we have wrapped the flight around the hub. All dirt augers feature a hard-faced carry section and head with the three fluted TriFlow® pilot and 201/211 taper fit dirt teeth.

Contact Your Pengo Rep to Configure Your Foundation Auger Today!



SPOT ON!
Configuring & Quoting

FLAT BOTTOM DIRT AUGER



PARTS | Pilot Bits



TF-600	TF-600	TF-1000	SD-60-175
with 1.75" square stem	use PA-182 or 141L Drive Lug	with 2.5" square stem	with 1.75" square stem
LBS 16	LBS 8.5	LBS 43	LBS 15
PN 137331	PN 137357	PN 137348	PN 135983
1.75 Adapter	141L Adapter	2.5 Adapter	1.75 Adapter
LBS 4.3	LBS 1.3	LBS 17.84	LBS 4.3
PN 151593	PN 151970	PN 151598	PN 151593

PARTS | Taper Fit Teeth



132	201	211	299
LBS 2	LBS 2.1	LBS 2.9	LBS 2.8
PN 134406	PN 170030	PN 170034	PN 134659
20 pc. Bucket	20 pc. Bucket	20 pc. Bucket	20 pc. Bucket
LBS 40	LBS 42	LBS 58	LBS 56
PN 850236	PN 850226	PN 850227	PN 850228

Pallet quantities available.

PARTS | Bucket Teeth

Pengo Foundation Dirt Augers can be built with the following Bucket Teeth!



X220	X330
LBS 6	LBS 12.2
PN 210250	PN 210254

use 220 Bucket Adapter (PN 210190) and P160 Roll Pin (PN 210256) to complete assembly

use 330 Bucket Adapter (PN 210192) and P330 Flex Pin (PN 210257) to complete assembly

INSTALLATION & REMOVAL TOOLS



716 Punch	PRT 160	PRT 290
LBS 3	LBS 3	LBS 3
Installation	for P160	for P330
PN 210197	PN 210196	PN 210198



WO-8 Pocket
LBS 2.5
PN 171577



Horseshoe Nail
LBS .1
PN 137620

May Be Used with Taper Fit Teeth To Secure Teeth In Place.





S-PATTERN DIRT AUGER

Double Cut and Double Carry shown

Standard Flight Thickness for Lead and Carry Sections: 1", 1 1/2" and 2"

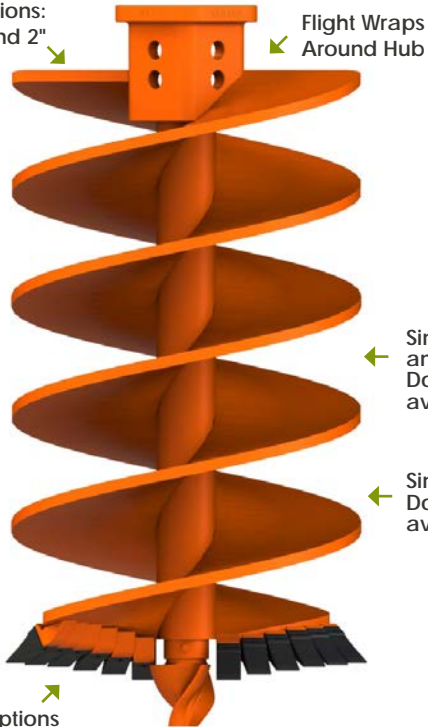

TriFlow® 1000 Pilot

Double Cut Single Carry

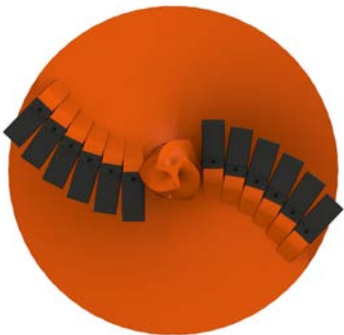

CONNECTIONS			AUGER DIAMETERS	
SQUARE	3"	3 1/2"	24"	TO 120"
SQUARE	133MM	150MM		
SQUARE	177MM	200MM		

CUT DIAMETER
True Cut diameter is equal to the auger diameter.

DRILLING SOIL CONDITIONS:



The PENGU foundation dirt augers withstand the rigors of your job. Both double cut, single carry and double cut, double carry augers feature the TriFlow® pilot bit and taper-fit dirt teeth.

The hard-faced flight comes in thickness of 1" or 1 1/2" standard, other thickness are available upon request.

Contact Your Pengo Rep to Configure Your Foundation Auger Today!



SPOT ON!
Configuring & Quoting

S-PATTERN DIRT AUGER



PARTS | Pilot Bits



TF-600
with 1.75" square stem
LBS 16
PN 137331



TF-600
use PA-182 or 141L Drive Lug
LBS 8.5
PN 137357



TF-1000
with 2.5" square stem
LBS 43
PN 137348



SD-60-175
with 1.75" square stem
LBS 15
PN 135983

1.75 Adapter
LBS 4.3
PN 151593

141L Adapter
LBS 1.3
PN 151970

2.5 Adapter
LBS 17.84
PN 151598

1.75 Adapter
LBS 4.3
PN 151593



PARTS | Taper Fit Teeth



132
LBS 2
PN 134406



201
LBS 2.1
PN 170030



211
LBS 2.9
PN 170034



299
LBS 2.8
PN 134659

20 pc. Bucket
LBS 40
PN 850236

20 pc. Bucket
LBS 42
PN 850226

20 pc. Bucket
LBS 58
PN 850227

20 pc. Bucket
LBS 56
PN 850228

PARTS | Bucket Teeth



X220
LBS 6
PN 210250

use 220 Bucket Adapter (PN 210190) and P160 Roll Pin (PN 210256) to complete assembly



X330
LBS 12.2
PN 210254

use 330 Bucket Adapter (PN 210192) and P330 Flex Pin (PN 210257) to complete assembly

INSTALLATION & REMOVAL TOOLS



716 Punch
LBS 3
Installation
PN 210197



PRT 160
LBS 3
for P160
PN 210196



PRT 290
LBS 3
for P330
PN 210198



WO-8 Pocket
LBS 2.5
PN 171577



Horseshoe Nail
LBS .1
PN 137620

May Be Used with Taper Fit Teeth To Secure Teeth In Place.

Pallet quantities available.



S-PATTERN ROCK AUGER

Double Cut and Double Carry shown

V1

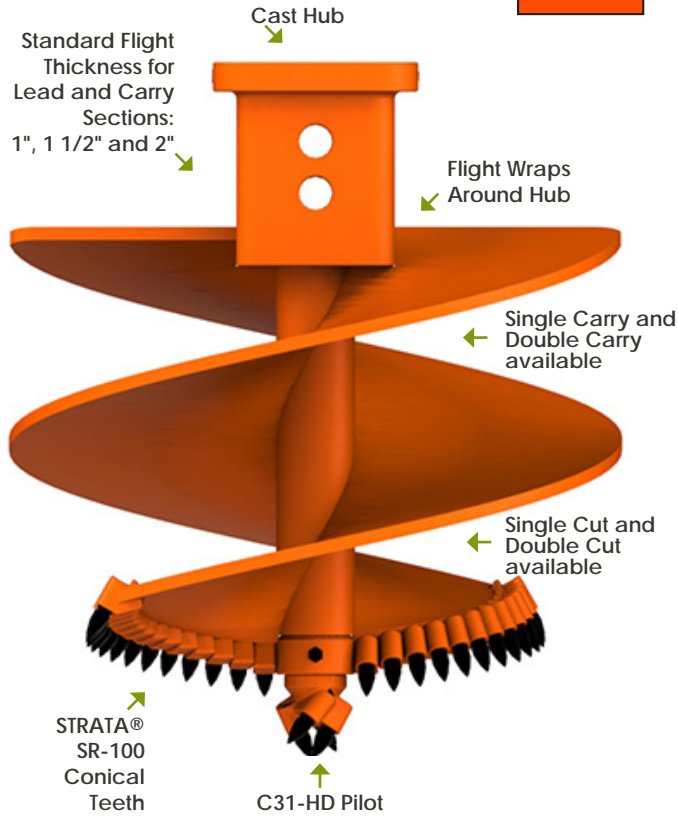

CONNECTIONS			AUGER DIAMETERS	
SQUARE	3"	3 1/2"	24"	TO 120"
SQUARE	133MM	150MM		
SQUARE	177MM	200MM		

CUT DIAMETER
True Cut diameter is equal to the auger diameter.

DRILLING SOIL CONDITIONS:

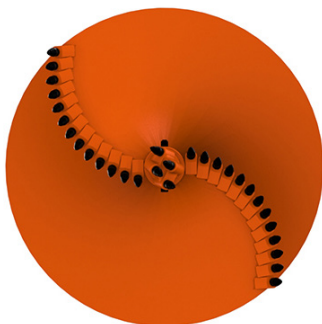
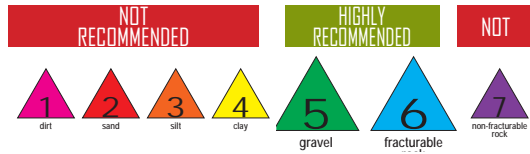

Contact Your Pengo Rep to Configure Your Foundation Auger Today!



SPOT ON!
Configuring & Quoting



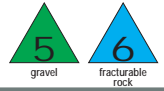

Pengo makes every effort to provide you with a solid, quality tool. Our Foundation V1 rock augers feature an single row, S-pattern cutting edge that provides peak performance in hard, fracturable rock drilling.

These augers are built with a cast or fabricated hub and your choice of flight thickness. The pinnacle of the Pengo's rock auger is the Strata® teeth. The special drilling grade carbide make Strata® top in it's class when it comes to life-cycle and performance.





S-PATTERN ROCK AUGER



PARTS | Pilot Bits

			
C31HD with 1Pin and Washer LBS 30 PN 135913	C31HD with Nut and Bolt LBS 30 PN 135936	B47-10 with 4" square stem LBS 72 PN 137965	C4-1 with 2.5" square stem LBS 30 PN 135971
2.5 Adapter LBS 17.84 PN 151598	2.5 Adapter LBS 17.84 PN 151598	4" Adapter LBS 43 PN 135904	2.5 Adapter LBS 17.84 PN 151598

PARTS | Conical Teeth

				
S31-HD 1" Shank LBS 1.1 ea. PN 850037	S-31 1" Shank LBS 1.05 ea. PN 850026	S-22 Step Shank LBS 2.6 ea. PN 850039	SR-104 Step Shank LBS 2.6 ea. PN 850024	S4-1 Step Shank LBS 2.6 ea. PN 850038
35 pc. Bucket LBS 38.5 PN 850210	35 pc. Bucket LBS 36.75 PN 850208	10 pc. Bucket LBS 26 PN NA	15 pc. Bucket LBS 37.95 PN 850207	15 pc. Bucket LBS 39 PN 850211

P30 Holder
12 pc bucket
PN 850224

For 1" Shank Conical Teeth

P4 Holder
8 pc bucket
PN 850225

For Step Shank Conical Teeth

Pallet quantities available on conical teeth.

ACCESSORIES | Installation & Removal Tools

		
Soft Hammer LBS 3.5 PN 137737	C30 Puller For 1" Shank Conical Teeth LBS 3 PN 134090	BZ-12 Puller For Step Shank Conical Teeth LBS 3 PN 850043

To prevent carbide on conical teeth from breaking, Pengo highly recommends using a soft hammer during installation of bullet teeth.

For ease of conical tooth removal use these designated pullers for 1" and Step Shank Conical Teeth.

TRIDENT

U.S. PATENT NO. D778,967

One Holder, Three Teeth for Pengo Foundation Augers!

			
NRH-100 Fits 1" shank tooth LBS 2.4 ea. PN 990088	NRW-100 LBS 1.33 ea. PN 990098	SR-100 LBS .56 ea. PN 850023	NR-100 LBS .99 ea. PN 990092
			
NRH-3038 Fits Step shank tooth LBS 4.86 ea. PN 990086	NRW-122 LBS 4.5 ea. PN 990096	SR-122 LBS 2.6 ea. PN 850034	NR-122 LBS 2.46 ea. PN 990089



DOUBLE ROW ROCK AUGER

Double Cut and Double Carry shown

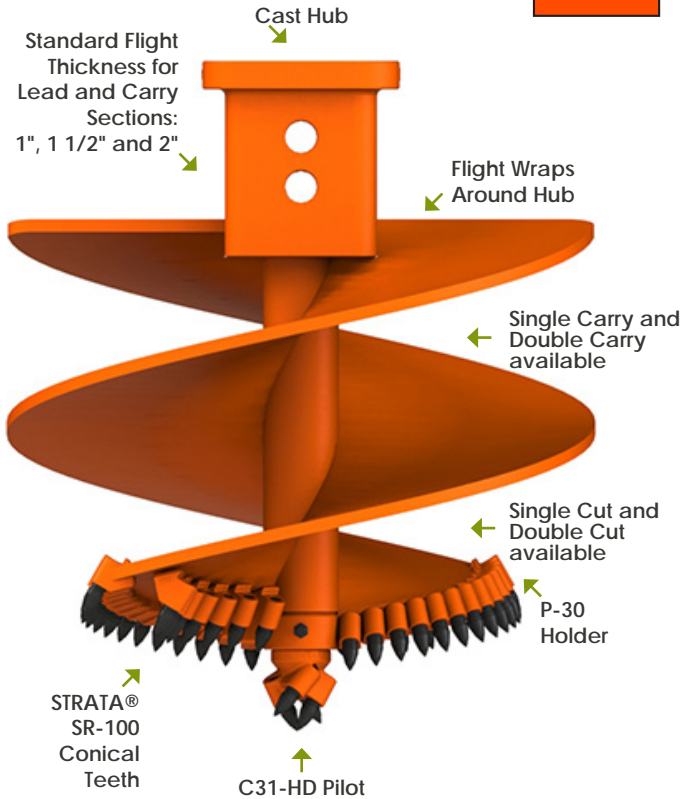

CONNECTIONS			AUGER DIAMETERS	
SQUARE	3"	3 1/2"	24"	TO 120"
SQUARE	133MM	150MM		
SQUARE	177MM	200MM		

CUT DIAMETER
True Cut diameter is equal to the auger diameter.

DRILLING SOIL CONDITIONS:

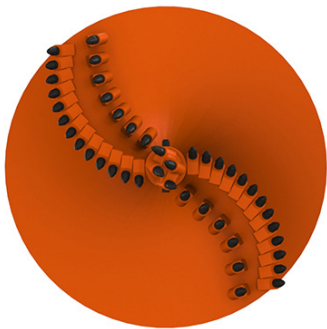
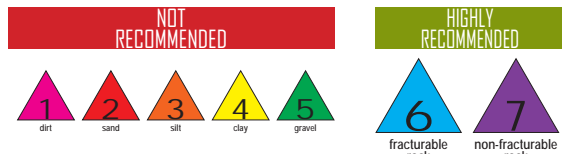

Contact Your Pengo Rep to Configure Your Foundation Auger Today!



SPOT ON!
Configuring & Quoting

When drilling conditions are extreme and there is a need for more carbide on the ground, the Double Row Rock Auger is your solution. The special carbide tip of the Strata® drilling grade conical tooth coupled with the dual S-pattern of the double row auger will hold up to the rigors of your job.

Strata® teeth have been proven to last longer than standard conical teeth thus meaning increased production time and productivity.

DOUBLE ROW ROCK AUGER

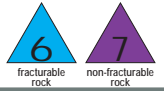

PARTS | Pilot Bits



C31HD

with 1Pin and Washer

LBS | 30

PN | 135913



C31HD

with Nut and Bolt

LBS | 30

PN | 135936



B47-10

with 4" square stem

LBS | 72

PN | 137965



C4-1

with 2.5" square stem

LBS | 30

PN | 135971

2.5 Adapter

LBS | 17.84

PN | 151598

2.5 Adapter

LBS | 17.84

PN | 151598

4" Adapter

LBS | 43

PN | 135904

2.5 Adapter

LBS | 17.84

PN | 151598

PARTS | Conical Teeth

STRATA



S31-HD

1" Shank

LBS | 1.1 ea.

PN | 850037



S-31

1" Shank

LBS | 1.05 ea.

PN | 850026



S-22

Step Shank

LBS | 2.6 ea.

PN | 850039



SR-104

Step Shank

LBS | 2.6 ea.

PN | 850024



S4-1

Step Shank

LBS | 2.6 ea.

PN | 850038

35 pc. Bucket

LBS | 38.5

PN | 850210

35 pc. Bucket

LBS | 36.75

PN | 850208

10 pc. Bucket

LBS | 26

PN | NA

15 pc. Bucket

LBS | 37.95

PN | 850207

15 pc. Bucket

LBS | 39

PN | 850211

P30 Holder
12 pc bucket
PN 850224



For 1" Shank
Conical Teeth

P4 Holder
8 pc bucket
PN 850225



For Step Shank
Conical Teeth

Pallet quantities
available on
conical teeth.

ACCESSORIES | Installation & Removal Tools

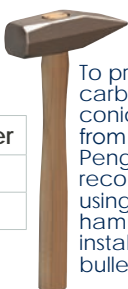

Soft Hammer

LBS | 3.5

PN | 137737

To prevent carbide on conical teeth from breaking, Pengo highly recommends using a soft hammer during installation of bullet teeth.



C30 Puller

For 1" Shank
Conical Teeth

LBS | 3

PN | 134090



BZ-12 Puller

For Step Shank
Conical Teeth

LBS | 3

PN | 850043

For ease of conical
tooth removal use
these designated
pullers for
1" and
Step Shank
Conical Teeth.



MODERATE SPIRAL ROCK AUGER

Double Cut and Double Carry shown

V3

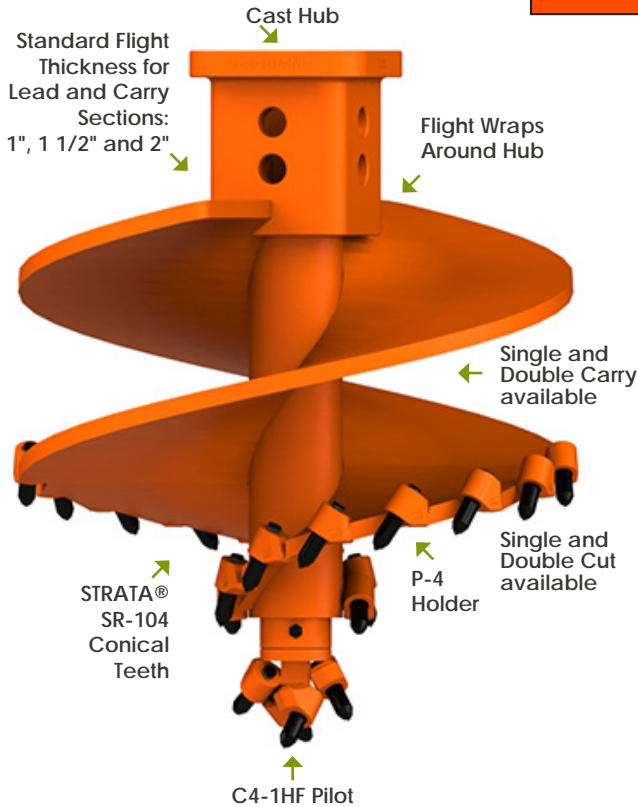

CONNECTIONS			AUGER DIAMETERS	
SQUARE	3"	3 1/2"	24"	TO 120"
SQUARE	133MM	150MM		
SQUARE	177MM	200MM		

CUT DIAMETER
True Cut diameter is equal to the auger diameter.

DRILLING SOIL CONDITIONS:

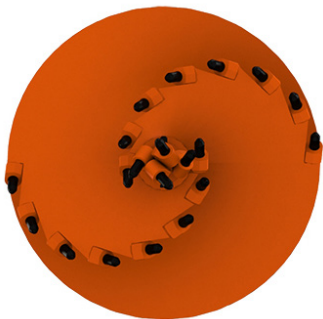
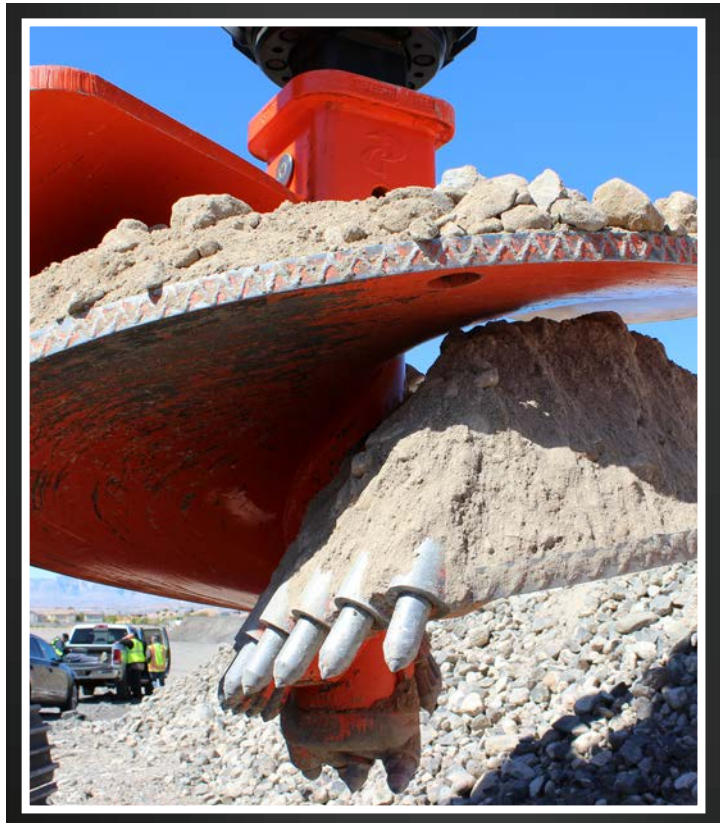
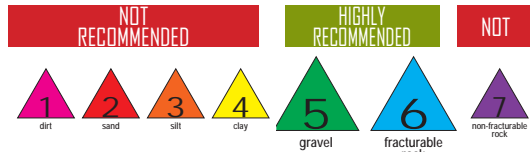

Contact Your Pengo Rep to Configure Your Foundation Auger Today!

ORANGE X PRESS

SPOT ON!
Configuring & Quoting



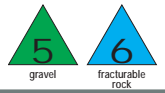

When selecting a tool for quick ground engagement, choose the Pengo Spiral Rock Auger. Designed for use on smaller foundation rigs, the spiral rock augers standard Strata® SR-104 Drilling grade teeth power through any fracturable rock conditions.

The heavy-duty P-4 holder design eliminates the need to fill large gaps when welding. With no excessive welding heat treat properties are kept in tact.





MODERATE SPIRAL ROCK AUGER



PARTS | Pilot Bits

			
C31HD with 1Pin and Washer LBS 30 PN 135913	C31HD with Nut and Bolt LBS 30 PN 135936	B47-10 with 4" square stem LBS 72 PN 137965	C4-1 with 2.5" square stem LBS 30 PN 135971
2.5 Adapter LBS 17.84 PN 151598	2.5 Adapter LBS 17.84 PN 151598	4" Adapter LBS 43 PN 135904	2.5 Adapter LBS 17.84 PN 151598

PARTS | Conical Teeth

				
S31-HD 1" Shank LBS 1.1 ea. PN 850037	S-31 1" Shank LBS 1.05 ea. PN 850026	S-22 Step Shank LBS 2.6 ea. PN 850039	SR-104 Step Shank LBS 2.6 ea. PN 850024	S4-1 Step Shank LBS 2.6 ea. PN 850038
35 pc. Bucket LBS 38.5 PN 850210	35 pc. Bucket LBS 36.75 PN 850208	10 pc. Bucket LBS 26 PN NA	15 pc. Bucket LBS 37.95 PN 850207	15 pc. Bucket LBS 39 PN 850211

P30 Holder 12 pc bucket PN 850224 *For 1" Shank Conical Teeth*

P4 Holder 8 pc bucket PN 850225 *For Step Shank Conical Teeth*

For Step Shank Conical Teeth

Pallet quantities available on conical teeth.

ACCESSORIES | Installation & Removal Tools

		
Soft Hammer LBS 3.5 PN 137737	C30 Puller For 1" Shank Conical Teeth LBS 3 PN 134090	BZ-12 Puller For Step Shank Conical Teeth LBS 3 PN 850043

To prevent carbide on conical teeth from breaking, Pengo highly recommends using a soft hammer during installation of bullet teeth.

For ease of conical tooth removal use these designated pullers for 1" and Step Shank Conical Teeth.

TRIDENT

U.S. PATENT NO, D778,967

One Holder, Three Teeth for Pengo Foundation Augers!

		
NRH-100 Fits 1" shank tooth LBS 2.4 ea. PN 990088		
		
NRW-100 LBS 1.33 ea. PN 990098		
		
SR-100 LBS .56 ea. PN 850023	NR-100 LBS .99 ea. PN 990092	
		
NRH-3038 Fits Step shank tooth LBS 4.86 ea. PN 990086		
		
NRW-122 LBS 4.5 ea. PN 990096	SR-122 LBS 2.6 ea. PN 850034	NR-122 LBS 2.46 ea. PN 990089



AGGRESSIVE SPIRAL ROCK AUGER

Double Cut and Double Carry shown

V5

CONNECTIONS			AUGER DIAMETERS	
SQUARE	3"	3 1/2"	24"	TO 120"
SQUARE	133MM	150MM		
SQUARE	177MM	200MM		

CUT DIAMETER
True Cut diameter is equal to the auger diameter.

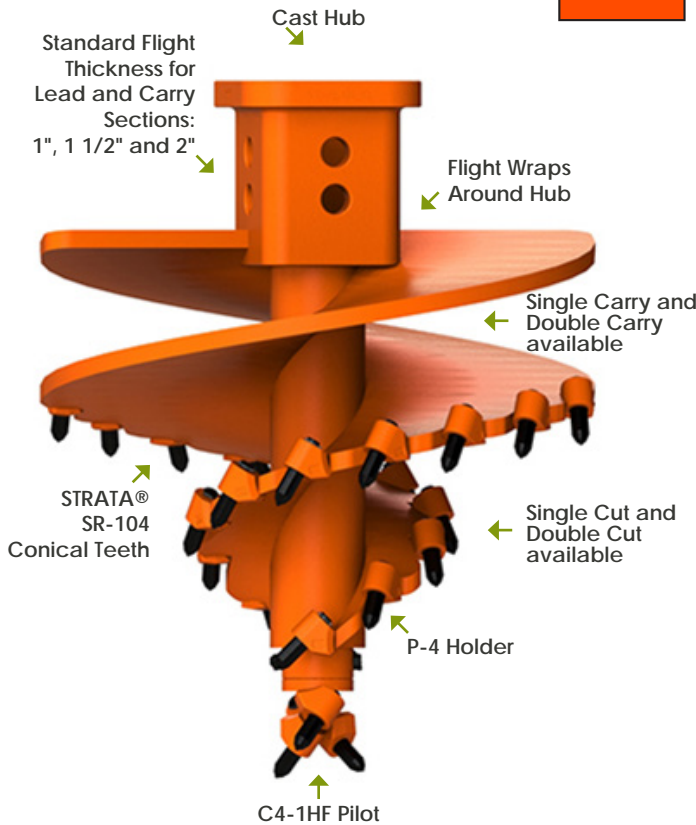

DRILLING SOIL CONDITIONS:

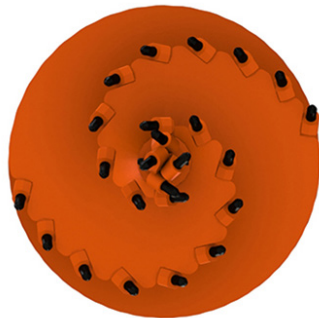
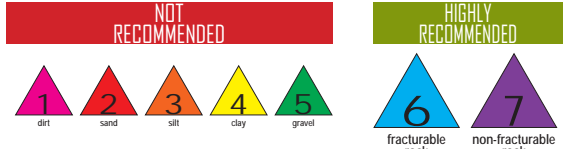

Contact Your Pengo Rep to Configure Your Foundation Auger Today!





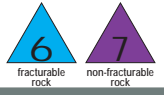

Pengo's Aggressive Spiral Rock Auger provides exceptional performance in fracturable and non-fracturable rock drilling conditions.

Both double cut, single carry and double cut, double carry augers feature the standard Strata® SR-104 Drilling grade teeth that power through tough drilling conditions.





AGGRESSIVE SPIRAL ROCK AUGER



PARTS | Pilot Bits

			
C31HD with 1Pin and Washer LBS 30 PN 135913	C31HD with Nut and Bolt LBS 30 PN 135936	B47-10 with 4" square stem LBS 72 PN 137965	C4-1 with 2.5" square stem LBS 30 PN 135971
2.5 Adapter LBS 17.84 PN 151598	2.5 Adapter LBS 17.84 PN 151598	4" Adapter LBS 43 PN 135904	2.5 Adapter LBS 17.84 PN 151598

PARTS | Conical Teeth

				
S31-HD 1" Shank LBS 1.1 ea. PN 850037	S-31 1" Shank LBS 1.05 ea. PN 850026	S-22 Step Shank LBS 2.6 ea. PN 850039	SR-104 Step Shank LBS 2.6 ea. PN 850024	S4-1 Step Shank LBS 2.6 ea. PN 850038
35 pc. Bucket LBS 38.5 PN 850210	35 pc. Bucket LBS 36.75 PN 850208	10 pc. Bucket LBS 26 PN NA	15 pc. Bucket LBS 37.95 PN 850207	15 pc. Bucket LBS 39 PN 850211

P30 Holder 12 pc bucket PN 850224 *For 1" Shank Conical Teeth*

P4 Holder 8 pc bucket PN 850225 *For Step Shank Conical Teeth*

STRATA Pallet quantities available on conical teeth.

ACCESSORIES | Installation & Removal Tools

		
Soft Hammer LBS 3.5 PN 137737	C30 Puller For 1" Shank Conical Teeth LBS 3 PN 134090	BZ-12 Puller For Step Shank Conical Teeth LBS 3 PN 850043





To prevent carbide on conical teeth from breaking, Pengo highly recommends using a soft hammer during installation of bullet teeth.

For ease of conical tooth removal use these designated pullers for 1" and Step Shank Conical Teeth.

TRIDENT

U.S. PATENT NO. D778,967

One Holder, Three Teeth for Pengo Foundation Augers!

			
NRH-100 Fits 1" shank tooth LBS 2.4 ea. PN 990088	NRW-100 LBS 1.33 ea. PN 990098	SR-100 LBS .56 ea. PN 850023	NR-100 LBS .99 ea. PN 990092
			
NRH-3038 Fits Step shank tooth LBS 4.86 ea. PN 990086	NRW-122 LBS 4.5 ea. PN 990096	SR-122 LBS 2.6 ea. PN 850034	NR-122 LBS 2.46 ea. PN 990089



STANDARD CORE BARREL

40" Barrel Length

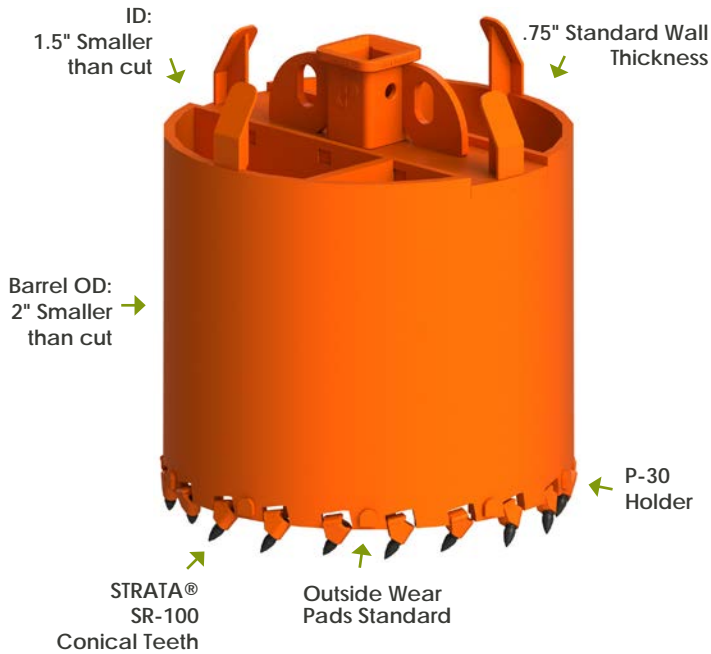

CONNECTIONS			AUGER DIAMETERS	
SQUARE	3"	3 1/2"	24"	TO 72"
SQUARE	133MM	150MM		
SQUARE	177MM	200MM		

CUT DIAMETER
True Cut diameter is equal to the auger diameter.

DRILLING SOIL CONDITIONS:

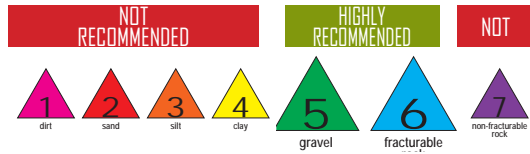

Contact Your Pengo Rep to Configure Your Core Barrel Today!



Pengo continually strives to provide the most efficient and effective tools in the field. The Pengo Core Barrel Assemblies are built to be used in hard rock drilling conditions. The standard features of the core barrel are Strata® SR-100 teeth, outside wearpads and guide bars. Pengo provides you the flexibility to custom build your core barrel with our OrangeXpress configurator. Contact your sales rep today to customize your core barrel today.

STANDARD CORE BARREL

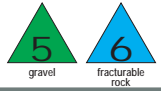

PARTS | Conical Teeth

STRATA



S31-HD	
1" Shank	
LBS 1.1 ea.	
PN 850037	
35 pc. Bucket	
LBS 38.5	
PN 850210	



S-31	
1" Shank	
LBS 1.05 ea.	
PN 850026	
35 pc. Bucket	
LBS 36.75	
PN 850208	

P30 Holder
12 pc bucket
PN 850224



For 1" Shank
Conical Teeth

Pallet quantities available
on conical teeth.



ACCESSORIES | Installation & Removal Tools



Soft Hammer
LBS 3.5
PN 137737

To prevent carbide on conical teeth from breaking, Pengo highly recommends using a soft hammer during installation of bullet teeth.



C30 Puller
For 1" Shank Conical Teeth
LBS 3
PN 134090



BZ-12 Puller
For Step Shank Conical Teeth
LBS 3
PN 850043

For ease of conical
tooth removal use
these designated
pullers for 1" and
Step Shank
Conical Teeth.

TRIDENT® SERIES | Holder and Teeth

NRH-100		
Fits 1" shank tooth		
LBS 2.4 ea.		
PN 990088		

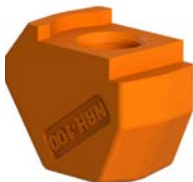

SR-100	
LBS .56 ea.	
PN 850023	



NR-100
LBS .99 ea.
PN 990092



NRW-100	
LBS 1.33 ea.	
PN 990098	

TRIDENT
U.S. PATENT NO. D778,967

One Holder, Three Teeth for
Pengo Foundation Augers!

Choose from
Strata Conical Teeth,
Non-Rotating Radial Teeth
and
Non-Rotating Wedge Teeth



HEAVY-DUTY CORE BARREL

40" Barrel Length 6" Core Ring

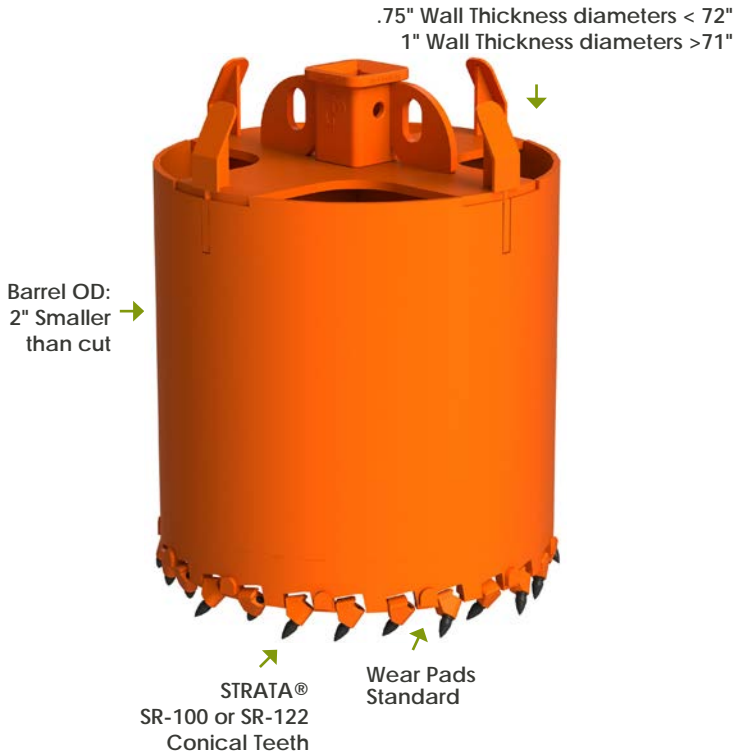

CONNECTIONS			AUGER DIAMETERS	
SQUARE	3"	3 1/2"	24"	TO 72"
SQUARE	133MM	150MM		
SQUARE	177MM	200MM		

CUT DIAMETER
True Cut diameter is equal to the auger diameter.

DRILLING SOIL CONDITIONS:

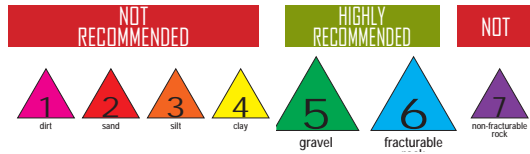

Contact Your Pengo Rep to Configure Your Core Barrel Today!



A recent addition to the Pengo Foundation Tooling product line is the Heavy-Duty Core Barrel. A standard feature to the HD Core Barrel is a heavy-duty top plate with full length gussets and a 1 1/4" thick core ring.

The addition of the top plate sets this apart from the standard barrel as it can withstand more crowd force, and with the help of the thick core ring, power through the toughest drilling conditions.

HEAVY-DUTY CORE BARREL

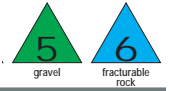

PARTS | Conical Teeth

S31-HD	S-31	S-22
1" Shank	1" Shank	Step Shank
LBS 1.1 ea.	LBS 1.05 ea.	LBS 2.6 ea.
PN 850037	PN 850026	PN 850039
35 pc. Bucket	35 pc. Bucket	10 pc. Bucket
LBS 38.5	LBS 36.75	LBS 26
PN 850210	PN 850208	PN NA

P30 Holder
12 pc bucket
PN 850224



For 1" Shank
Conical Teeth

Pallet quantities available
on conical teeth.

ACCESSORIES | Installation & Removal Tools

Soft Hammer	C30 Puller	BZ-12 Puller
LBS 3.5	For 1" Shank Conical Teeth	For Step Shank Conical Teeth
PN 137737	LBS 3	LBS 3
	PN 134090	PN 850043

To prevent carbide on conical teeth from breaking, Pengo highly recommends using a soft hammer during installation of bullet teeth.

For ease of conical tooth removal use these designated pullers for 1" and Step Shank Conical Teeth.



TRIDENT

U.S. PATENT NO. D778,967

One Holder, Three Teeth for Pengo Foundation Augers!

NRH-100	NRW-100	SR-100	NR-100
Fits 1" shank tooth	Fits 1" shank tooth	Fits 1" shank tooth	Fits 1" shank tooth
LBS 2.4 ea.	LBS 1.33 ea.	LBS .56 ea.	LBS .99 ea.
PN 990088	PN 990098	PN 850023	PN 990092
NRH-3038	NRW-122	SR-122	NR-122
Fits Step shank tooth	Fits 1" shank tooth	Fits 1" shank tooth	Fits 1" shank tooth
LBS 4.86 ea.	LBS 4.5 ea.	LBS 2.6 ea.	LBS 2.46 ea.
PN 990086	PN 990096	PN 850034	PN 990089



SFL COMBO BUCKETS

40" Barrel Length

Patent No. 8,615,906

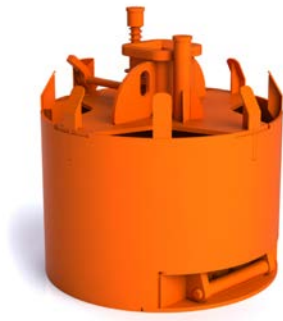

CONNECTIONS			AUGER DIAMETERS	
SQUARE SQUARE SQUARE	3"	3 1/2"	4"	24" TO 72"
	133MM	150MM		CUT DIAMETER <i>True Cut diameter is equal to the auger diameter.</i>
	177MM	200MM		

DRILLING SOIL CONDITIONS:

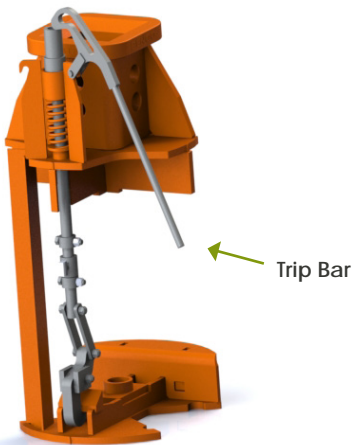
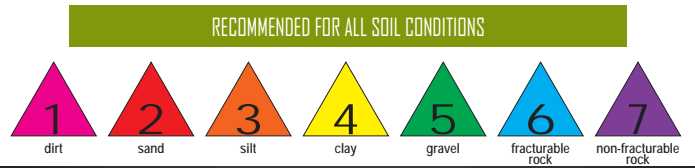

Three tools in one! Pengo provides yet another solution for your drilling needs. The rugged hard-faced combo bucket features a patented scissor latch and CAM activated release system. Located in the vent, the double-finger latch system (on buckets 36" dia. and larger) stays protected from the drilling spoils, thus allowing the scissor to function without any interference. Note: Buckets from 24" to 36" are single-finger latch, and are not projected like the double-finger latch.

The double open bottom design allows the operator to open the bottom plate either manually or automatically. Choose from dirt, rock or clean-out drill bottoms.

Contact Your Pengo Rep to Configure Your Core Barrel Today!



SPOT ON!
Configuring & Quoting



DFL COMBO BUCKETS

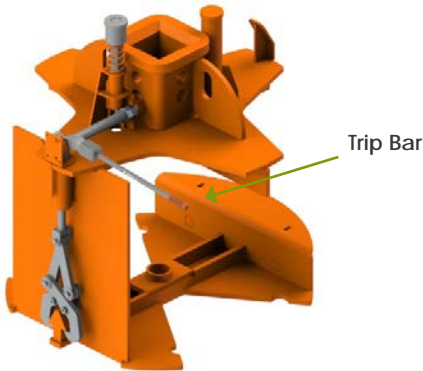

CONNECTIONS			AUGER DIAMETERS	
SQUARE	3"	3 1/2"	24"	TO 72"
SQUARE	133MM	150MM		
SQUARE	177MM	200MM		
			CUT DIAMETER <i>True Cut diameter is equal to the auger diameter.</i>	

DRILLING SOIL CONDITIONS:

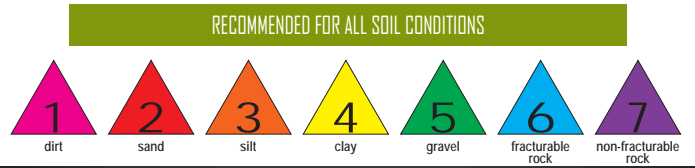

Three tools in one! Pengo provides yet another solution for your drilling needs. The rugged hard-faced combo bucket features a patented scissor latch and CAM activated release system. Located in the vent, the double-finger latch system (on buckets 36" dia. and larger) stays protected from the drilling spoils, thus allowing the scissor to function without any interference. Note: Buckets from 24" to 36" are single-finger latch, and are not projected like the double-finger latch.

The double open bottom design allows the operator to open the bottom plate either manually or automatically. Choose from dirt, rock or clean-out drill bottoms.

Contact Your Pengo Rep to Configure Your Core Barrel Today!



SPOT ON!
Configuring & Quoting



COMBO BUCKETS

PARTS | Dirt Bottom



TF-600 Pilot
with 1.75" square stem
LBS 16
PN 137331

TF-1000 Pilot
with 2.5" square stem
LBS 43
PN 137348

132 Tooth
LBS 2
PN 134406

WO-8 Pocket
LBS 2.5
PN 171577

X220
LBS 6
PN 210250

use 220 Bucket Adapter (PN 210190) and P160 Roll Pin (PN 210256) to complete assembly

1.75 Adapter
LBS 4.3
PN 151593

2.5 Adapter
LBS 17.84
PN 151598

Horseshoe Nail
LBS .1
PN 137620

X330
LBS 12.2
PN 210254

use 330 Bucket Adapter (PN 210192) and P330 Flex Pin (PN 210257) to complete assembly

PARTS | Rock Bottom



C31HD
with 1Pin & Washer
LBS 30
PN 135913

B47-10
with 4" square stem
LBS 72
PN 137965

S31-HD
1" Shank
LBS 1.1 ea.
PN 850037

S-31
1" Shank
LBS 1.05 ea.
PN 850026

S-22
Step Shank
LBS 2.6 ea.
PN 850039

716 Punch
LBS 3
Installation
PN 210197

PRT 160
LBS 3
for P160
PN 210196

PRT 290
LBS 3
for P330
PN 210198

2.5 Adapter
LBS 17.84
PN 151598

4" Adapter
LBS 43
PN 135904

35 pc. Bucket
LBS 38.5

35 pc. Bucket
LBS 36.75

10 pc. Bucket
LBS 26

P30 Holder
PN 850224

P4 Holder
PN 850225



One Holder, Three Teeth for Pengo Foundation Augers!



NRH-100
Fits 1" shank tooth
LBS 2.4 ea.
PN 990088

NRW-100
LBS 1.33 ea.
PN 990098

SR-100
LBS .56 ea.
PN 850023



NR-100
LBS .99 ea.
PN 990092



NRH-3038
Fits Step shank tooth
LBS 4.86 ea.
PN 990086

NRW-122
LBS 4.5 ea.
PN 990096

SR-122
LBS 2.6 ea.
PN 850034



NR-122
LBS 2.46 ea.
PN 990089





CLEANING BUCKETS

40" Barrel Length

.75" Wall Thickness dia. < 72"
1" Wall Thickness dia. > 71"



True Cut →

Spin Bottom



CONNECTIONS

SQUARE	3"	3 1/2"	4"
SQUARE	133MM	150MM	
SQUARE	177MM	200MM	

AUGER DIAMETERS

24" TO 72"

CUT DIAMETER

True Cut diameter is equal to the auger diameter.

DRILLING SOIL CONDITIONS:

RECOMMENDED FOR ALL SOIL CONDITIONS

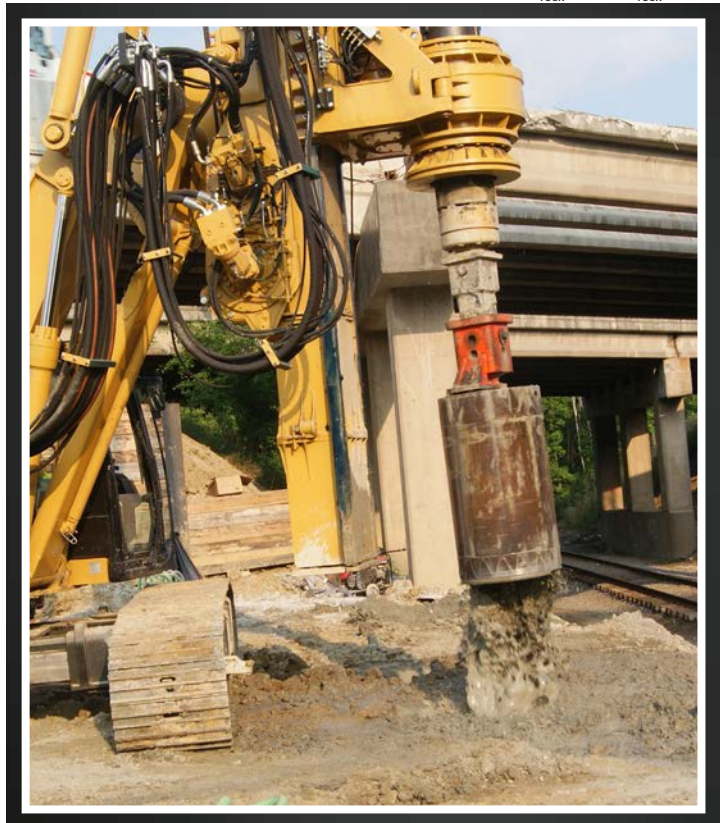
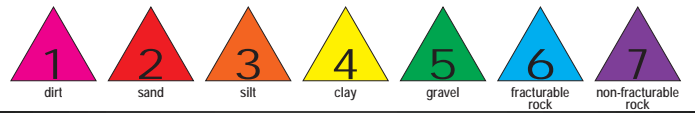

The Pengo cleaning bucket is your go-to option for removing material from the hole to create a clean base. The featured spin bottom ensures whether the bottom is closed or open, preventing spoil spills.

Contact Your Pengo Rep to Configure Your Core Barrel Today!



SPOT ON!
Configuring & Quoting

SPECIALTY TOOLS | HUBS & ADAPTERS



CASING ROTATORS | for Foundation Drills

The Pengo Casing Rotator is used to position casings into a hole that is being drilled in soils that may cave in.

The four adjustable arms are used to stabilize the soil in such conditions.

The casing rotator is available in three sizes; small, medium and large with a standard hub options. We offer special arm lengths upon request.

DIA	130MM	150MM	177MM	200MM
24"-42"	1000480	1000481	1000482	1000483
36"-60"	1000484	1000485	1000486	1000487
60"-100"	1000488	1000489	1000490	1000491



PAN AUGER | for Foundation Drills

You have challenges, we have solutions! The Pengo Pan Auger is a shallow auger that was designed to be used in retrieving large rocks and boulders out of a hole. A 4" hard-faced flight guard protects the rocks from falling off the edge. A pilot bit and/or special tooth options may be added for a combination of drilling and retrieving.



REAMER ARMS | for Foundation Augers

There comes a time when you need to extend the cut diameter of your auger. The Pengo rock or dirt reamer arm kits give you the option of increasing the diameter from 3" to 12".

REAMER ARM KITS

ITEM	TEETH (QTY)	PN
3" ROCK	SR122 (2)	138320
6" ROCK	SR122 (3)	138326
3" ROCK	SR100 (2)	138324
6" ROCK	SR100 (3)	138322
3" DIRT	211 (1)	138328
6" DIRT	211 (1) 132 (1)	138330

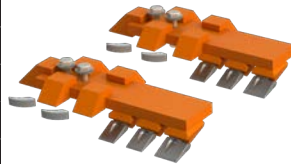

ASSEMBLIES

ITEM	TEETH (QTY)	PN
3" ROCK	SR122 (2)	138294
6" ROCK	SR122 (3)	138295
3" ROCK	SR100 (2)	138310
6" ROCK	SR100 (3)	138312
3" DIRT	211 (1)	138288
6" DIRT	211 (1) 132 (1)	138289



CAST SQUARE HUBS

ITEM	LBS.	PN
S300	40	154020
S350	52	154030
S400	65	154050
130MM	100	154161
150MM	175	154162
177MM	205	154163
200MM	390	154164



FABRICATED HUBS

ITEM	LBS.	PN
S300		154155
S350		154040
S400		154048
S425		880230
S525		154286
S700		880551
S725		880229
130MM		135851
150MM		880221
177MM		880222
200MM		136534



CAST SQUARE HUBS TALL

ITEM	LBS.	PN
200MM	328	154200



PENGO FOUNDATION AUGERS

800.599.0211